

3000

2000

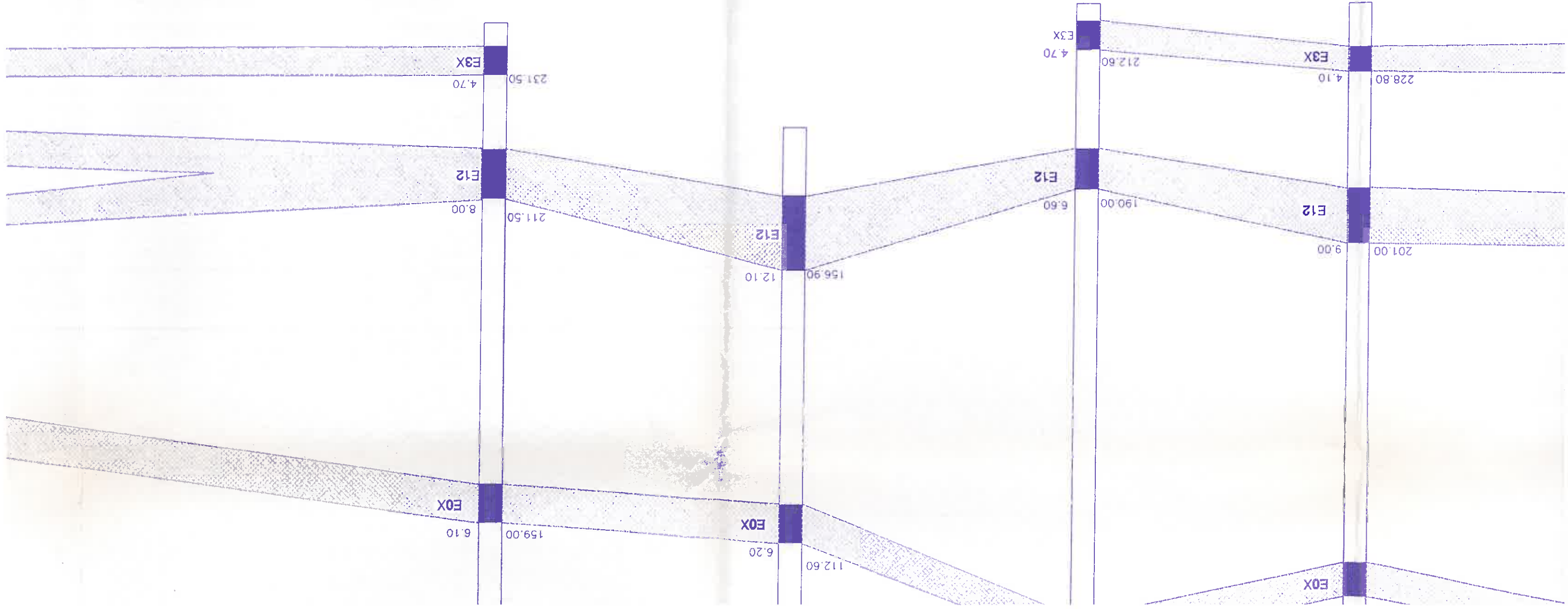

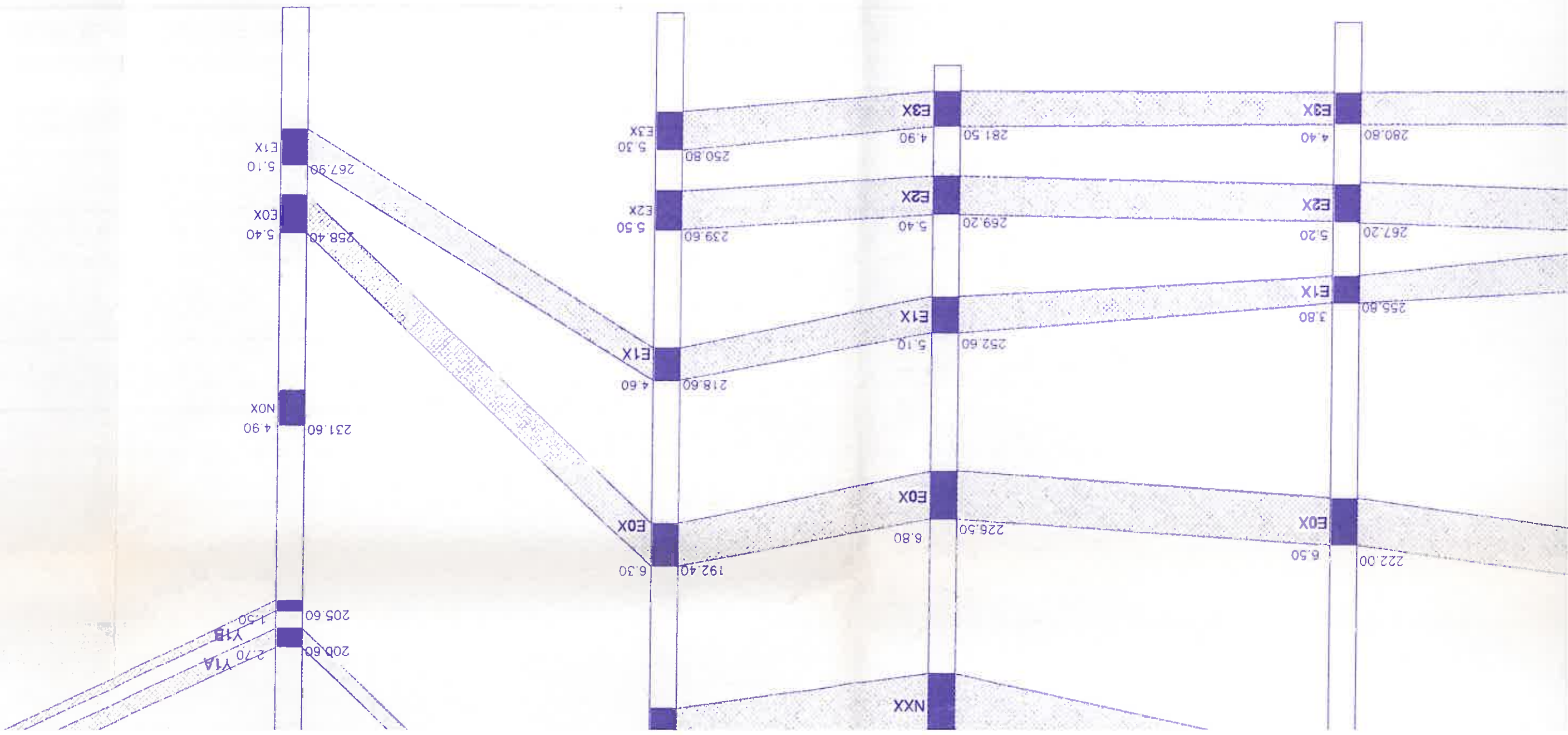

5000

6000

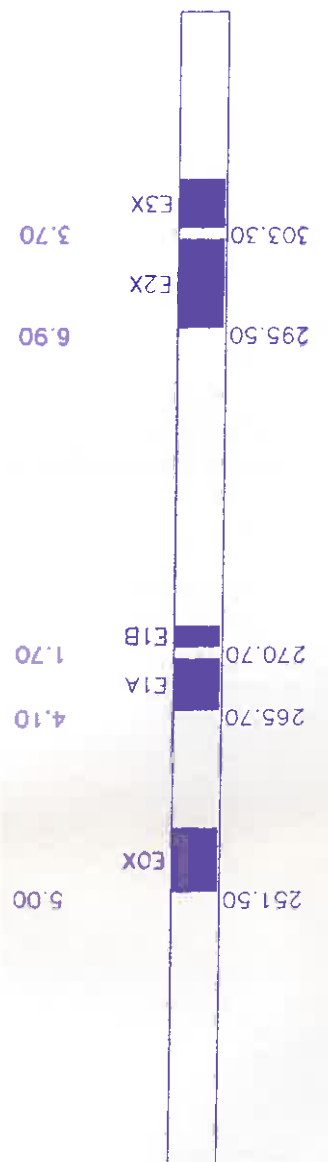

27565B
38513S
54103E

27566B
38514S
54449E

27366B
38518S
54776E

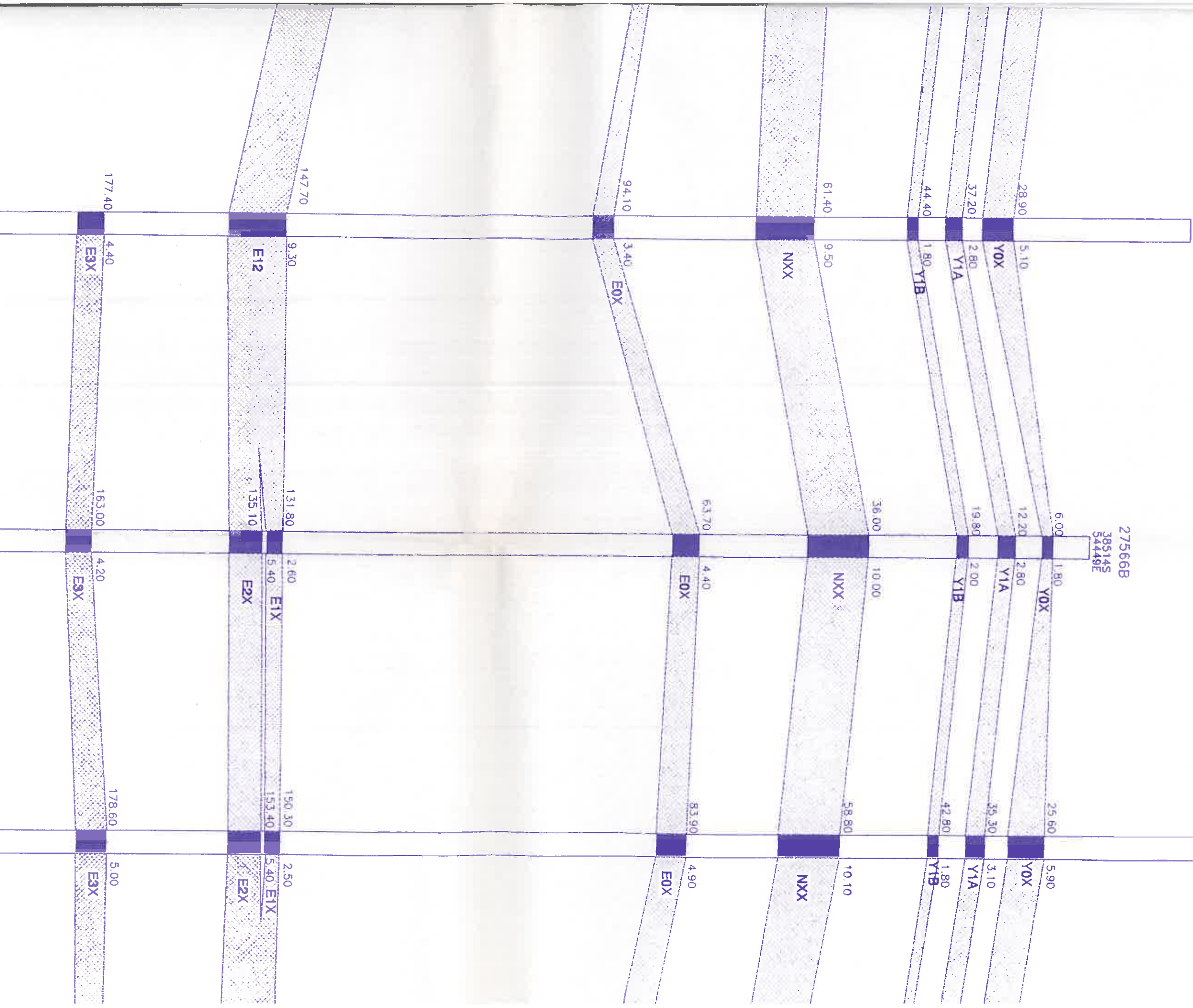

8000

7000

E3X 3.70
E2X 6.90
E1B 1.70
E1A 4.10
EOX 5.00

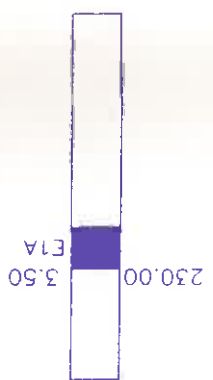

Peabody Western Coal Company

H: 1" = 100' V: 1" = 15'

TYPICAL GEOLOGICAL CROSS SECTION J-21 AREA #6

J21 AREA #6

TYPICAL GEOLOGICAL
CROSS SECTION

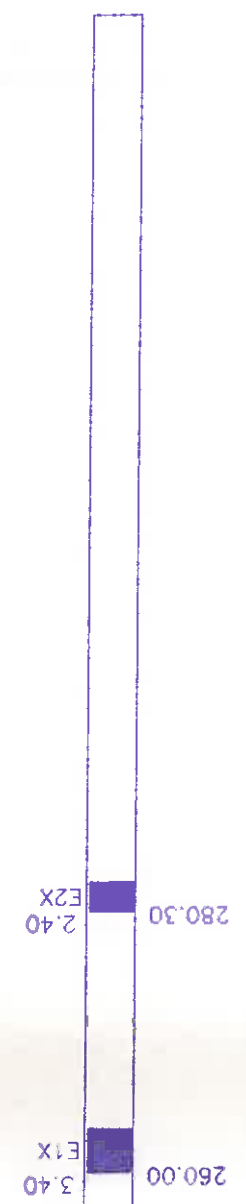

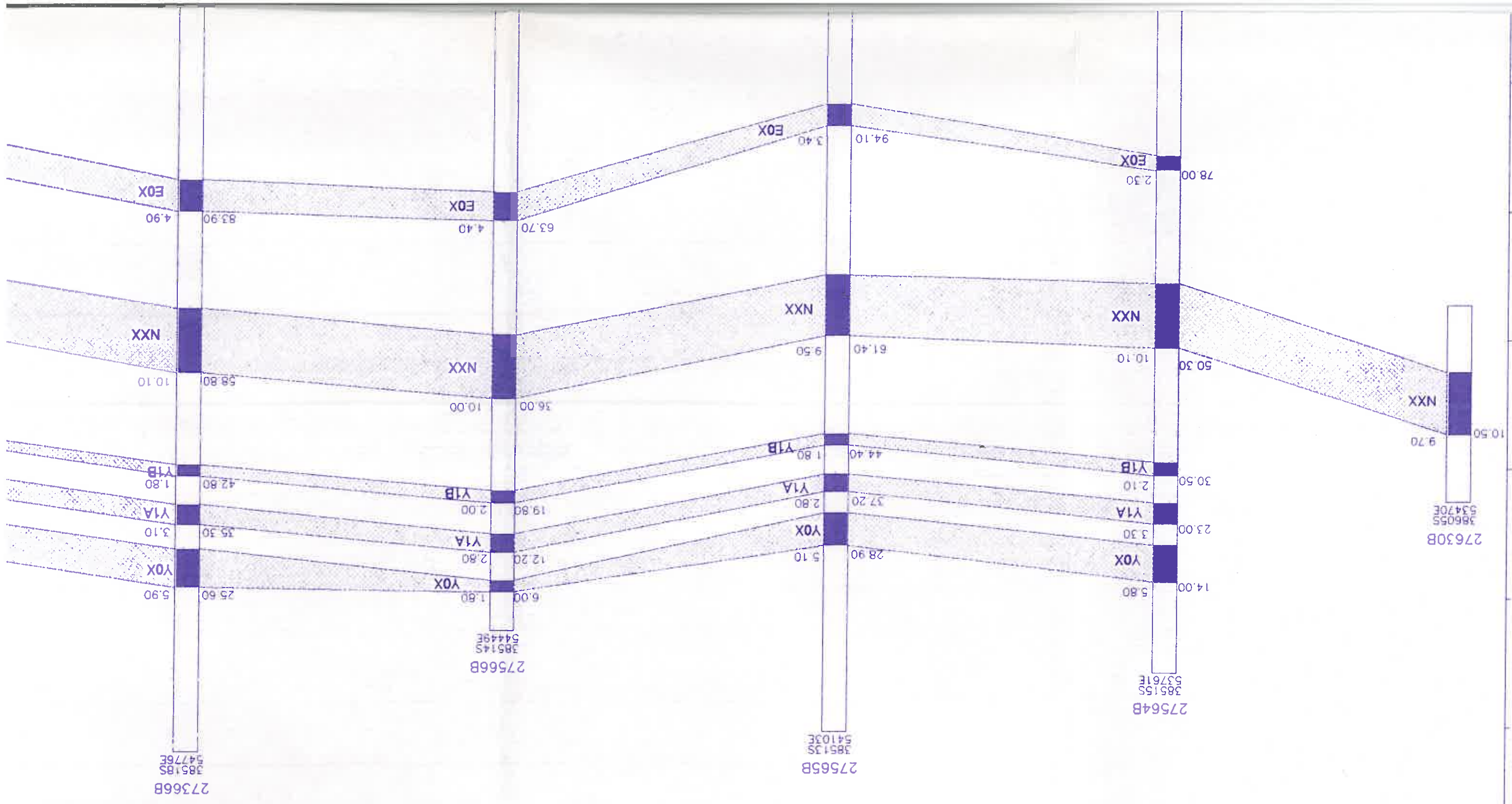

6800

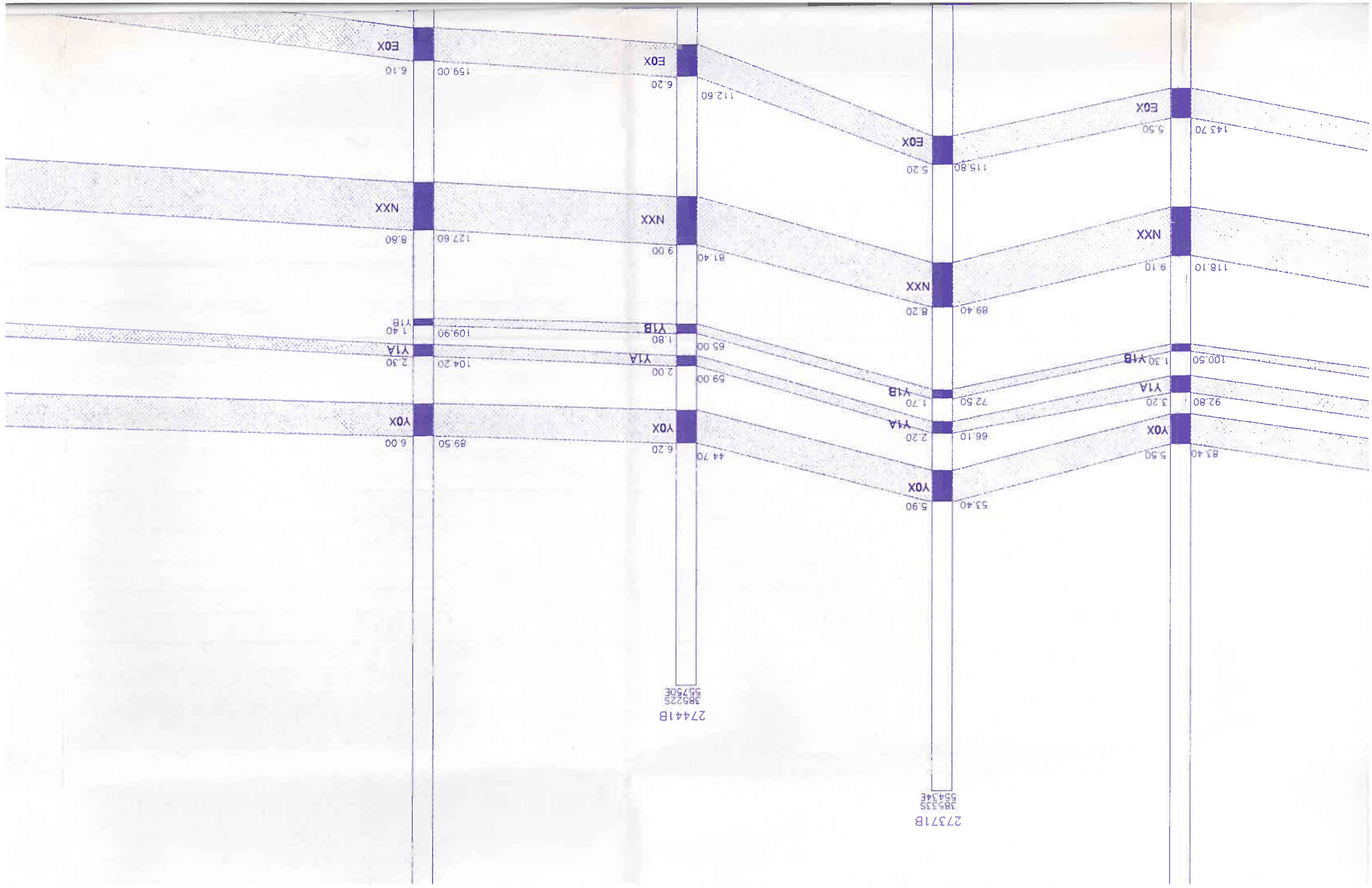

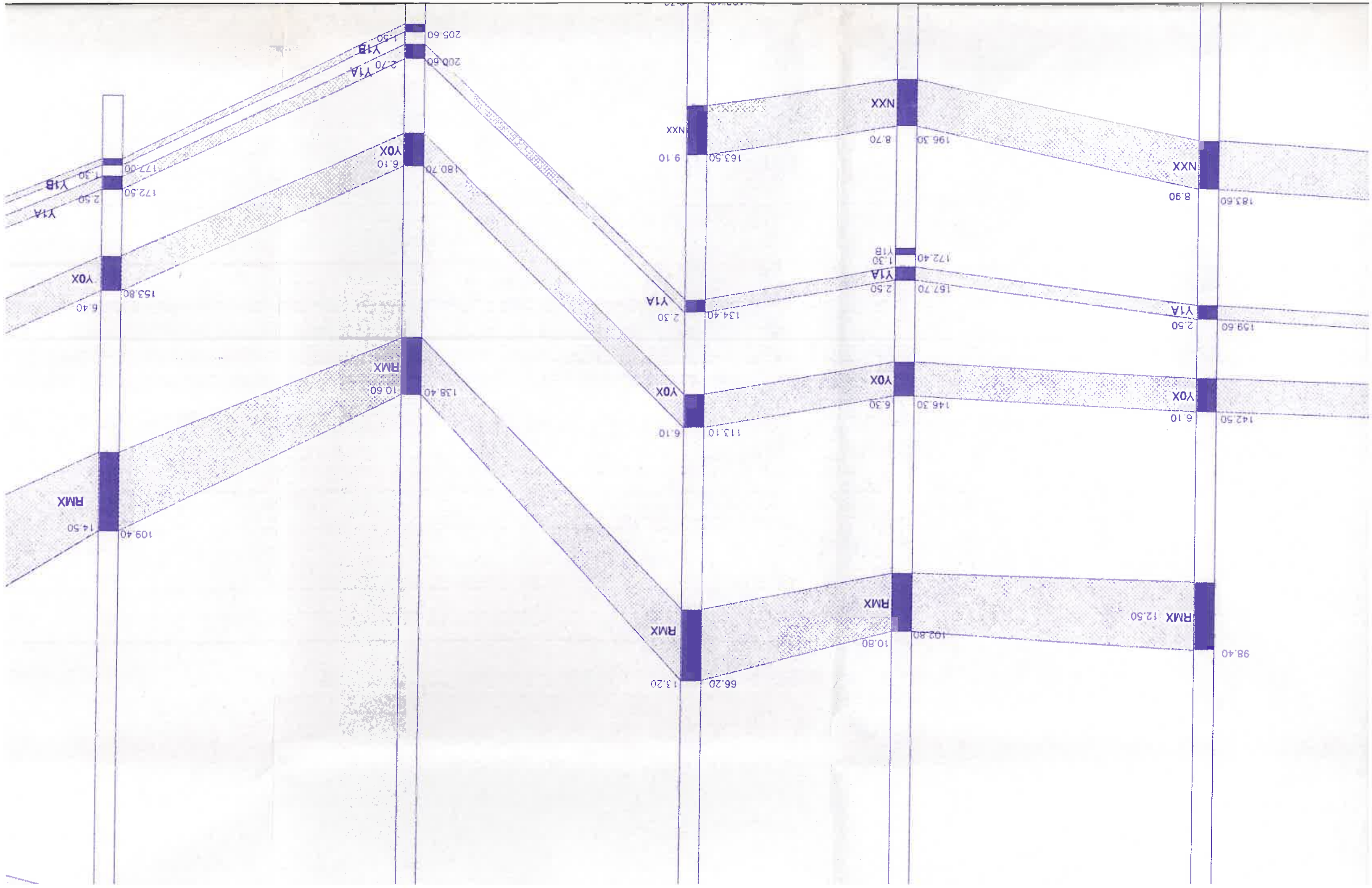

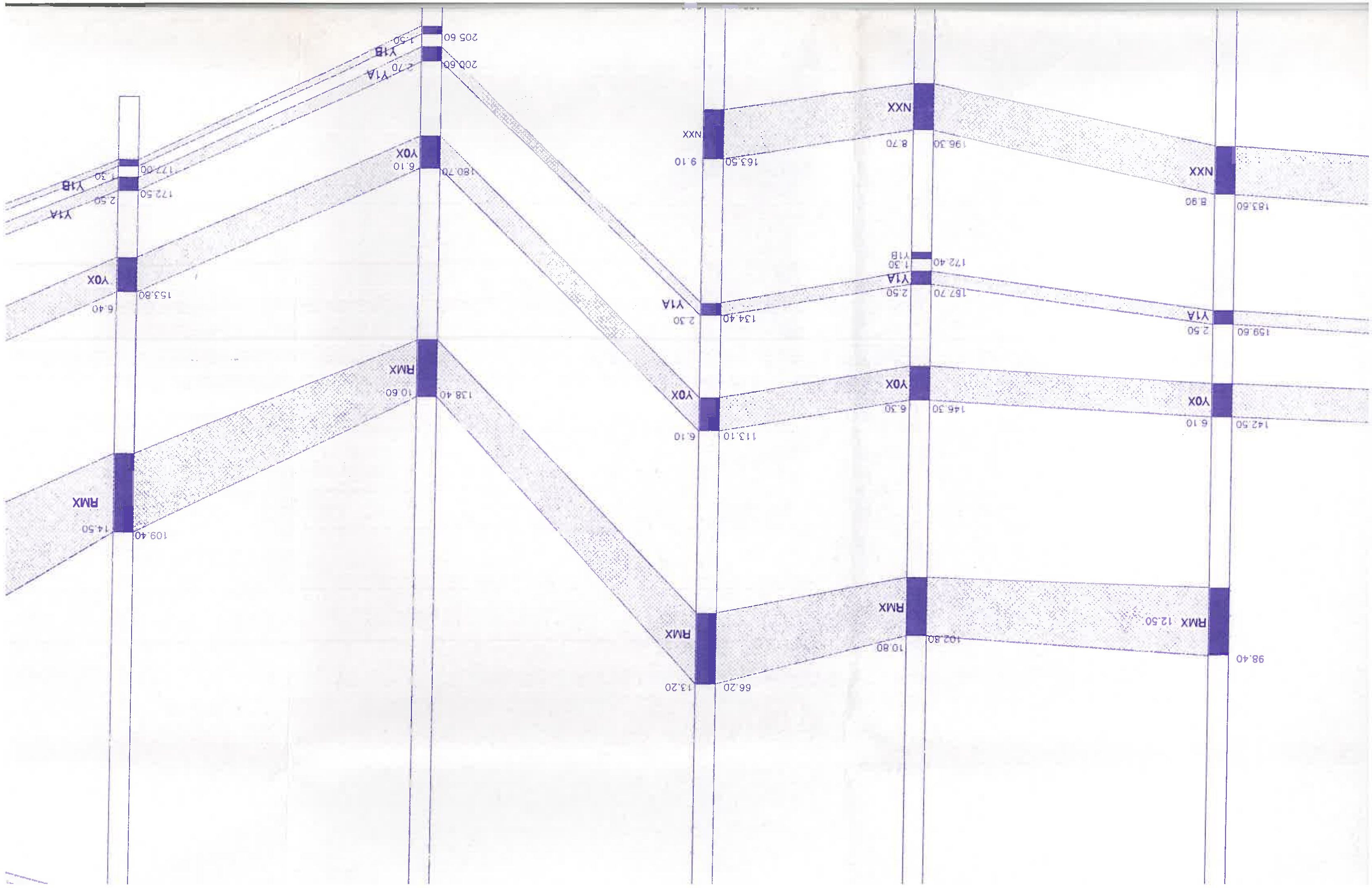

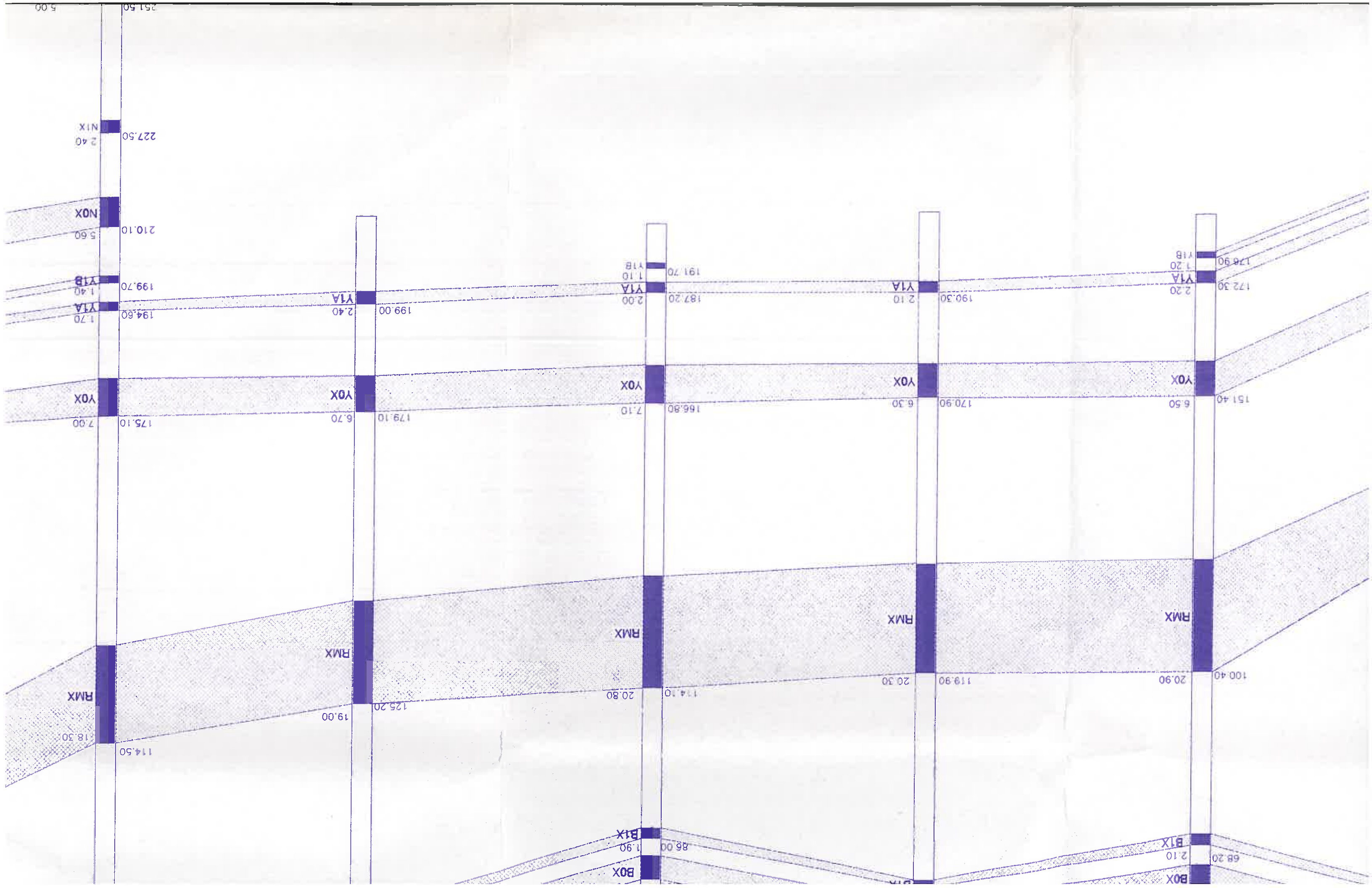

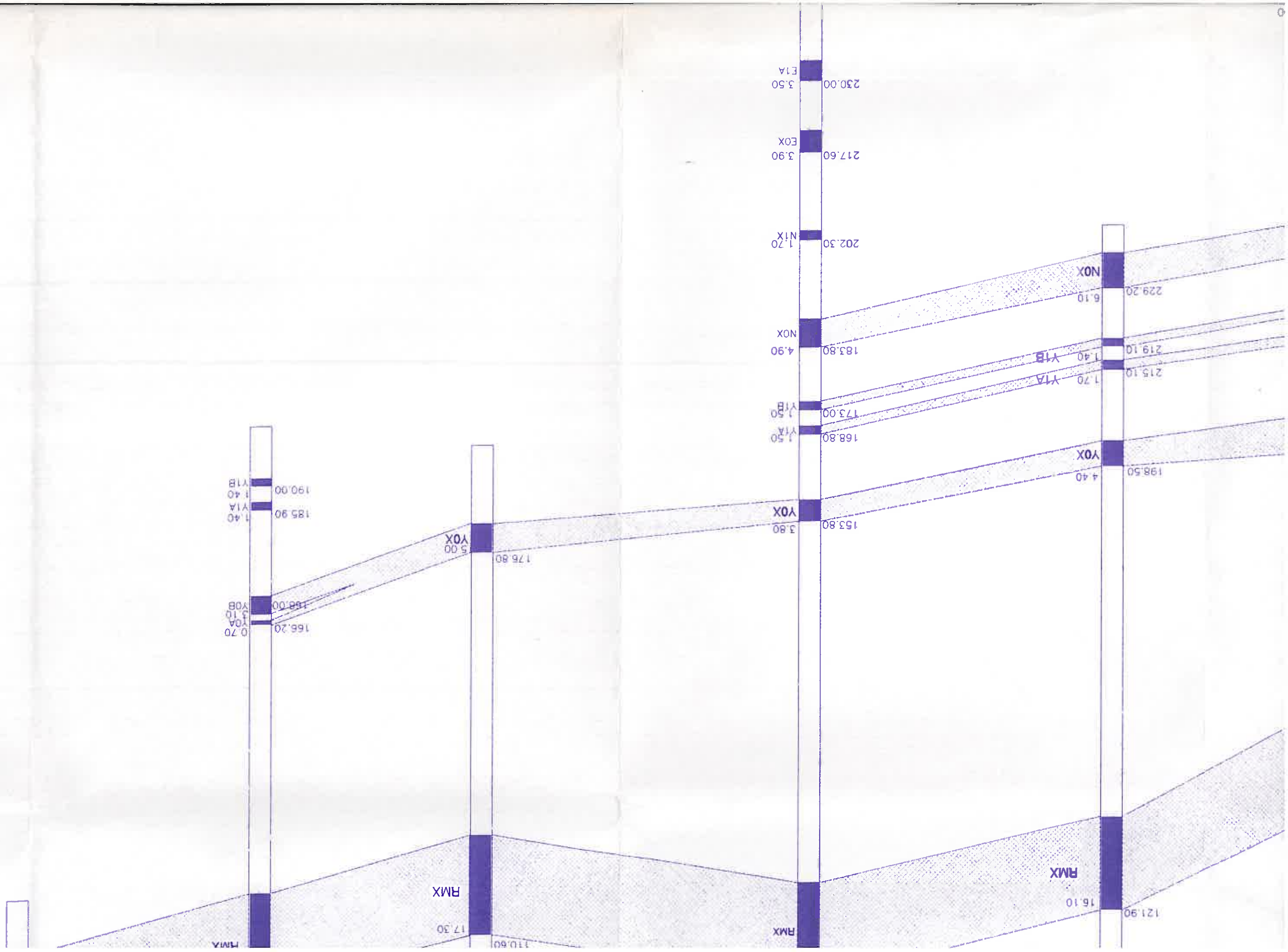

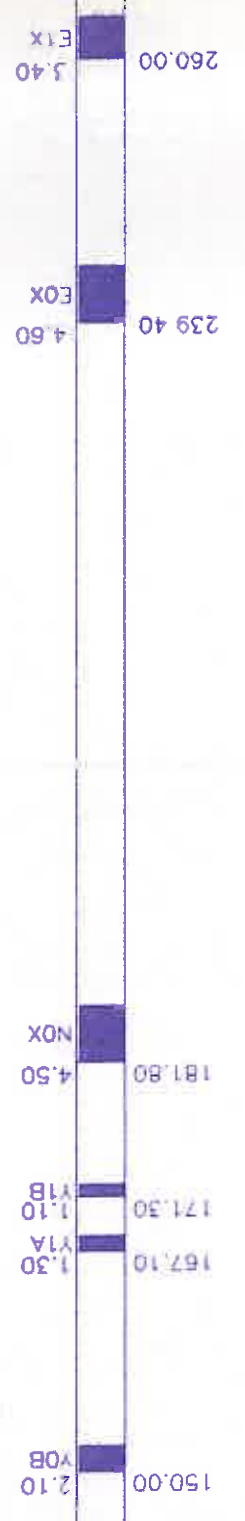

0069

7000

27380B
3851S
56074E

27371B
3853S
55434E

27369B
38514S
55139E

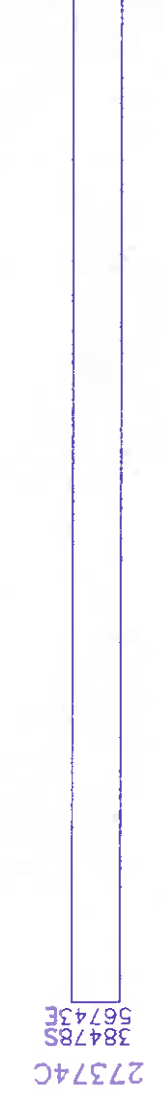
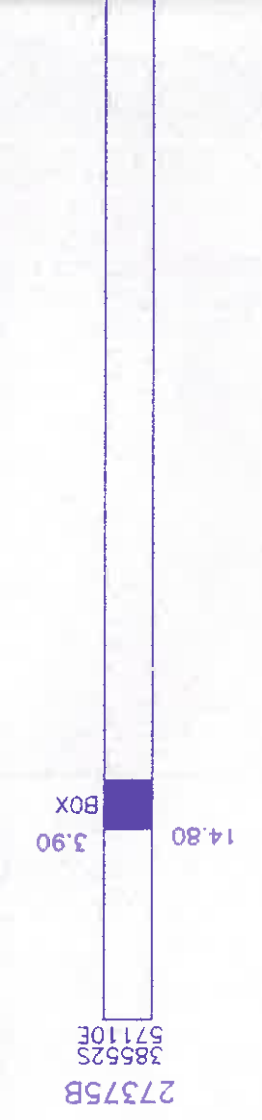
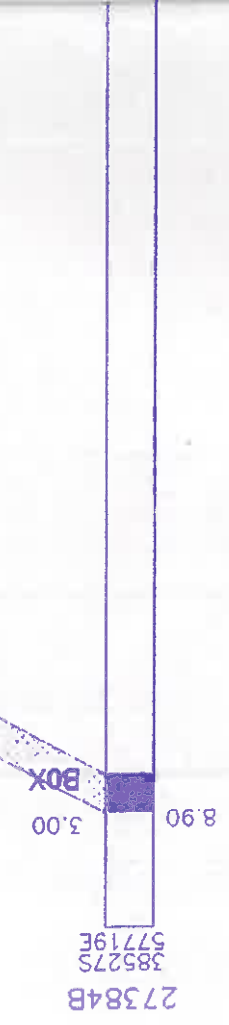
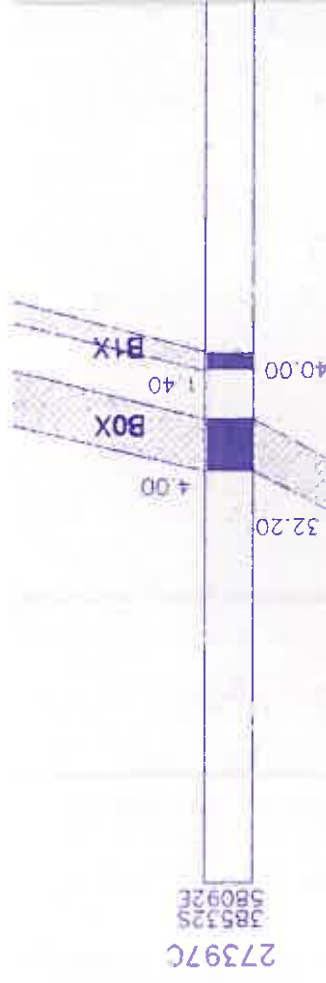

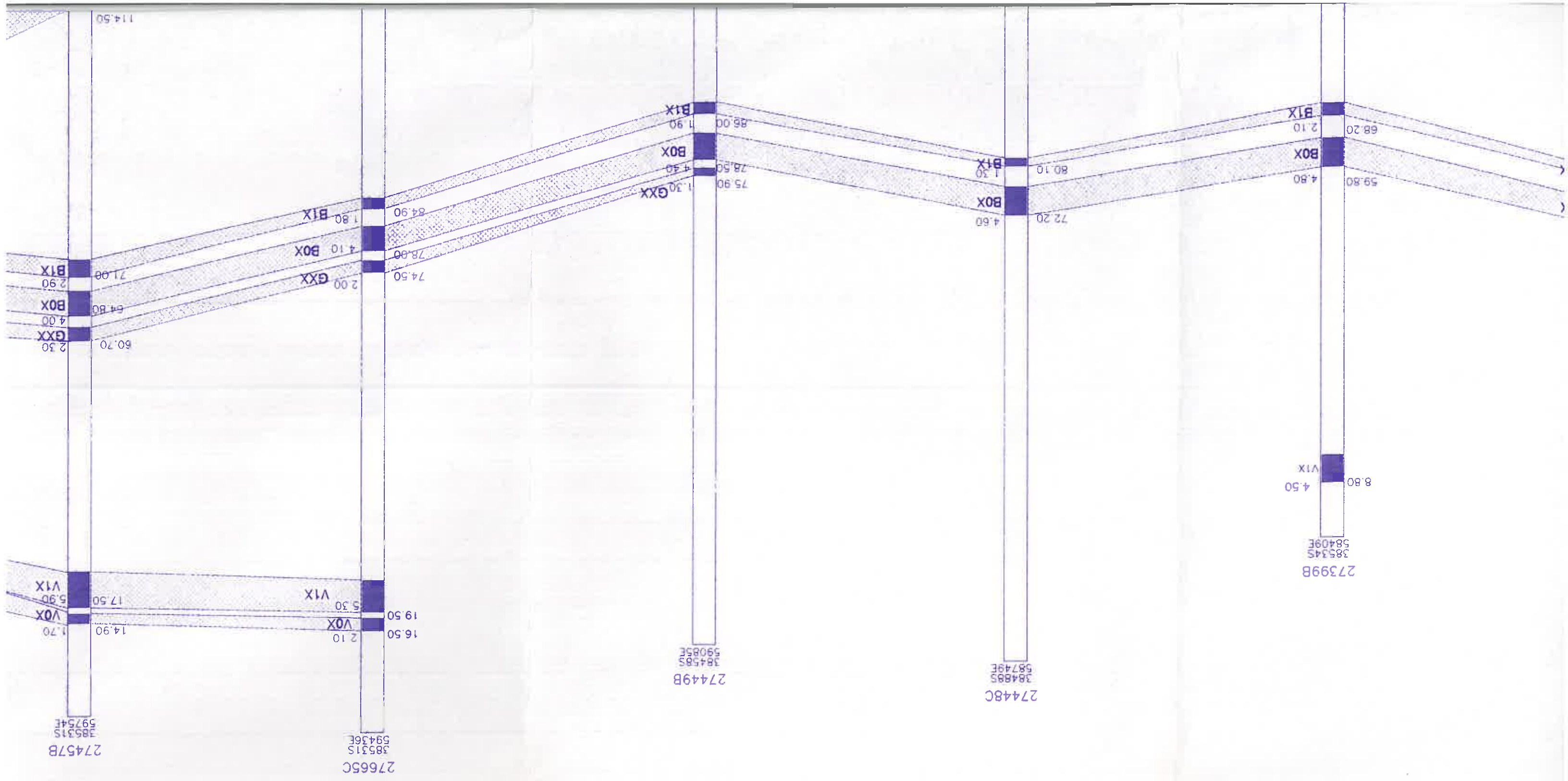

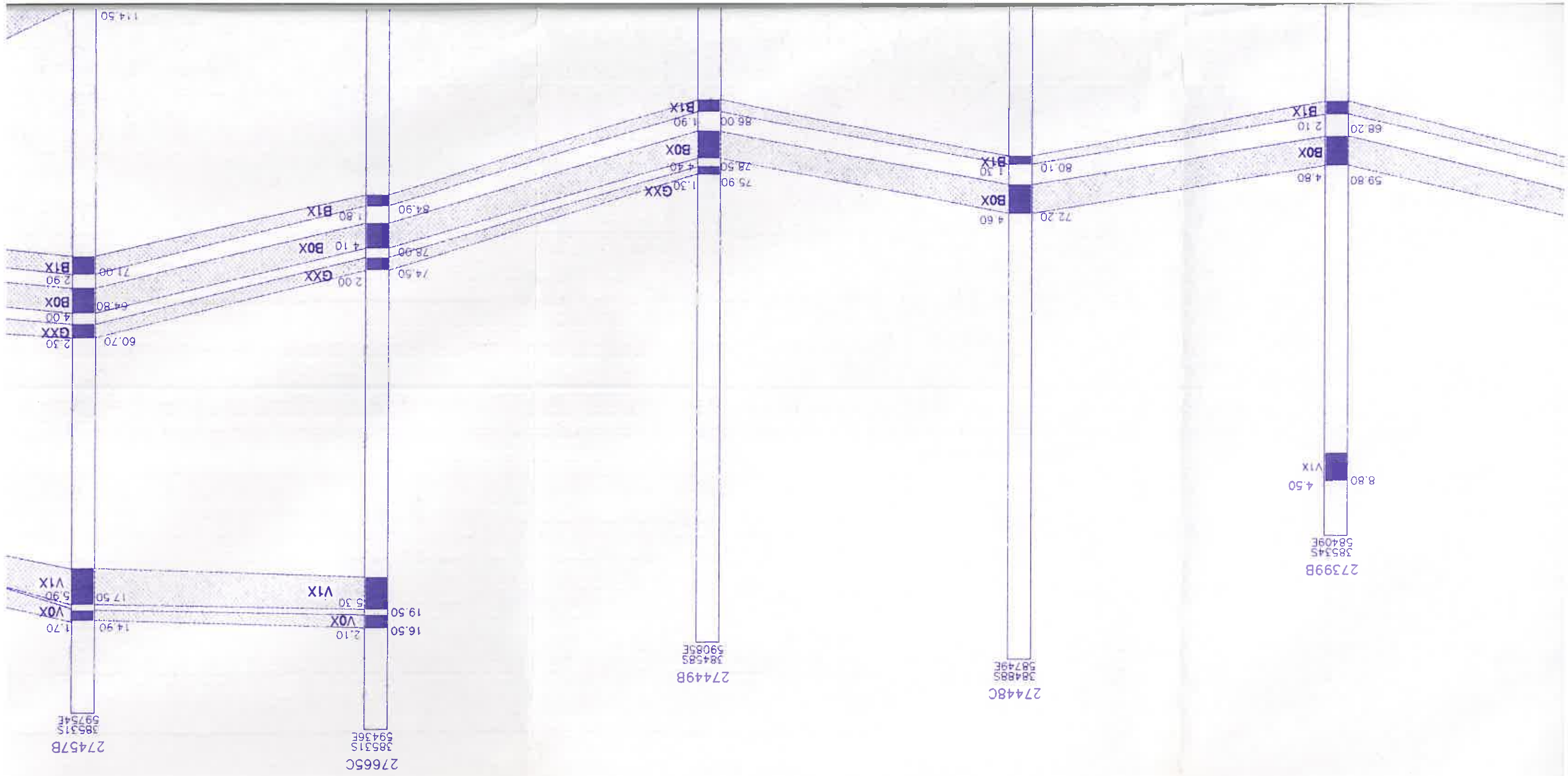

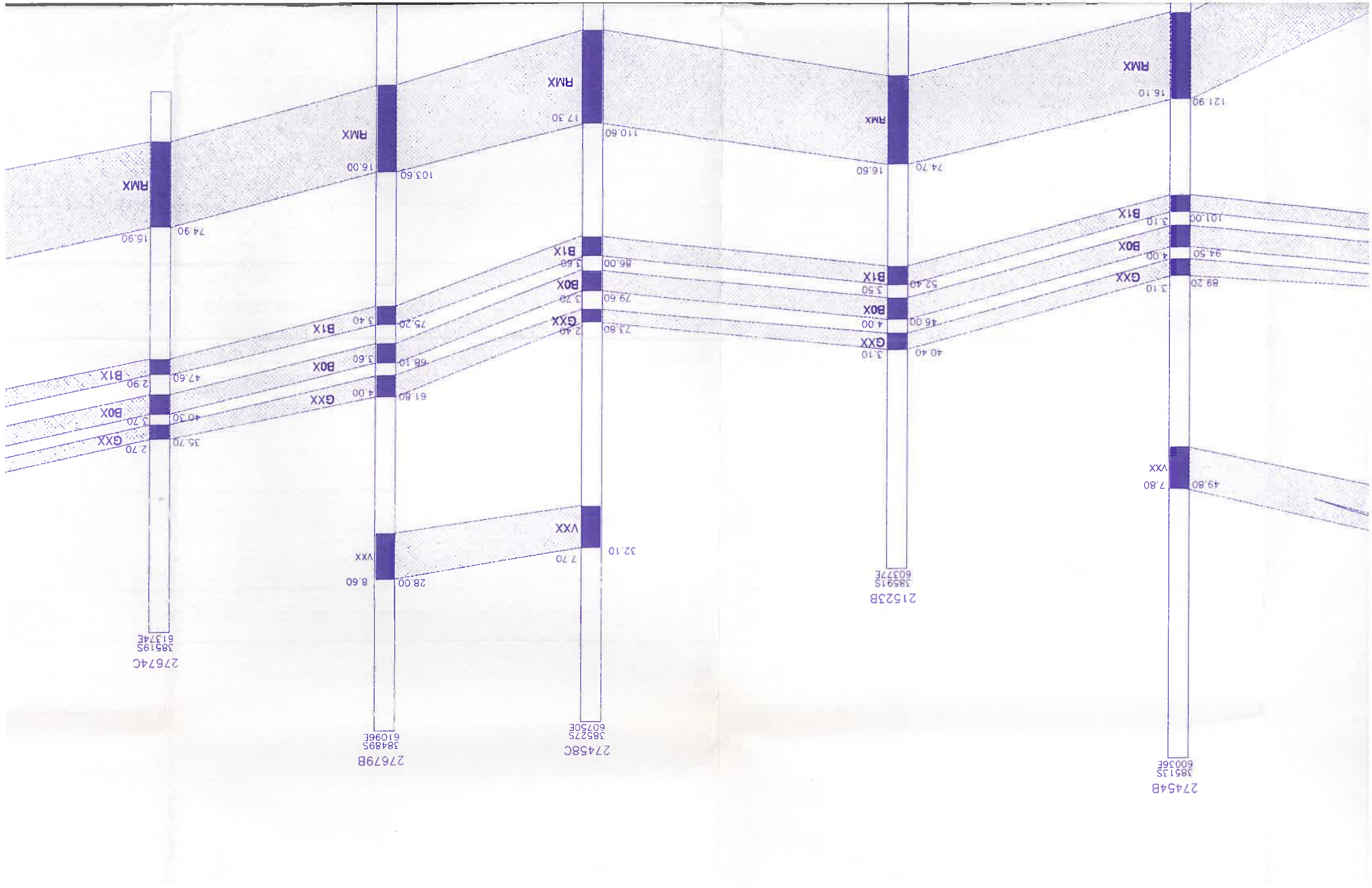

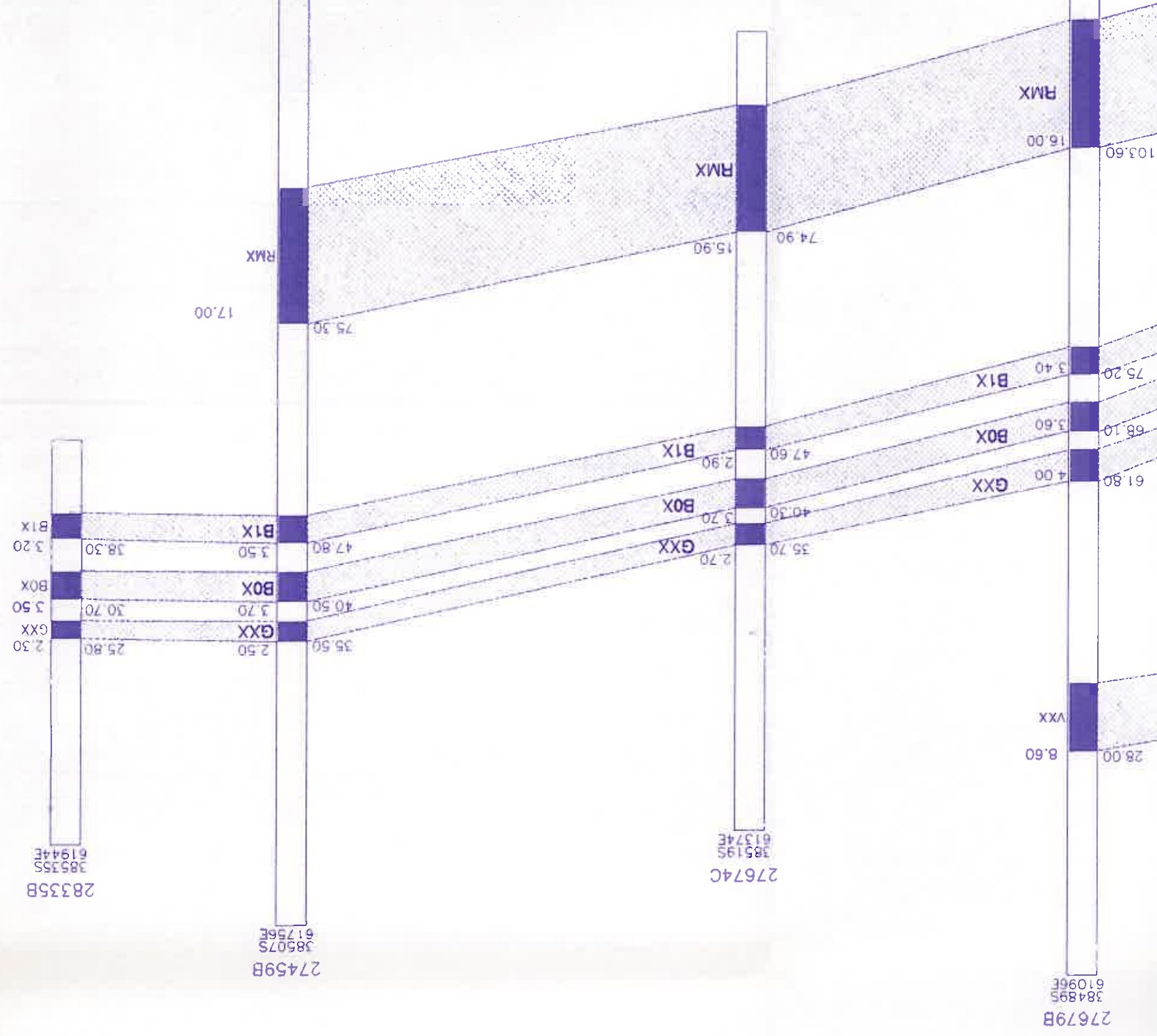

27679B
38489S
61096E



8.60

VXX

27674C
38519S
61374E



27459B
38507S
61756E



28335B
38535S
61944E



28.00

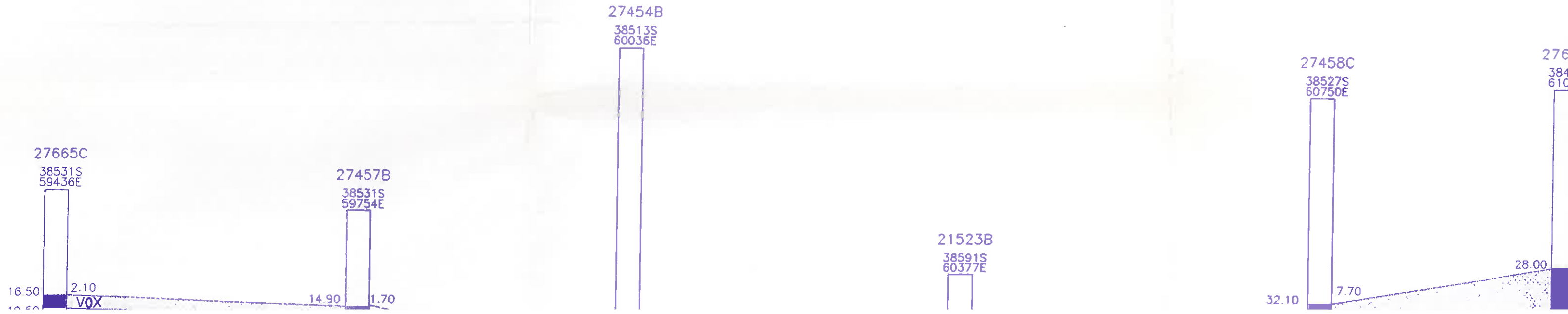

27448C
38488S
58749E



27449B
38458S
59085E









7100

7000

